

Clamex P-10

Pat. pend.

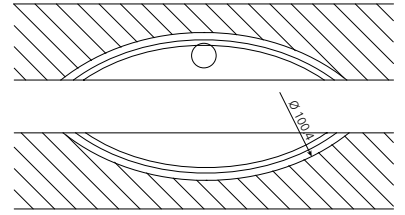
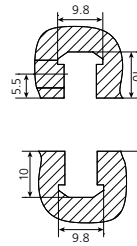
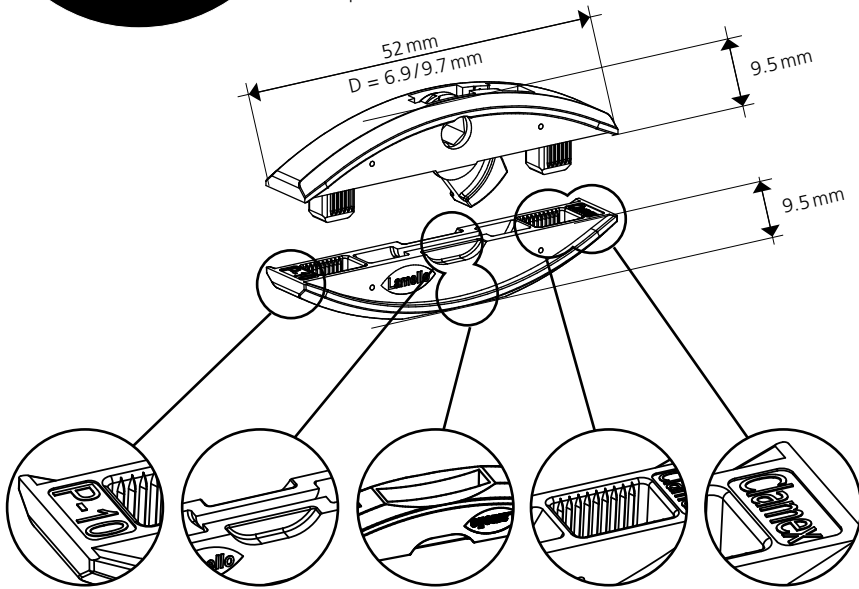
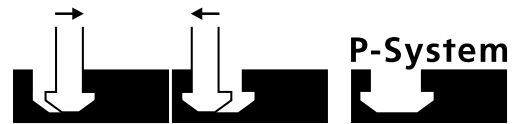

Zugfestigkeit / Tensile strength:

- Spanplatte / particle board:
~ 600 N = 60 kg
- Buche massiv / beech massive:
~ 900 N = 90 kg
- MDF:
~ 600 N = 60 kg

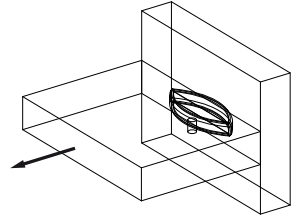

P-System Konfigurator auf unserer Webseite
P-system configurator on our website

Le configurateur P-System sur notre site Internet
Configuratore P-System sul nostro sito web

www.lamello.com/p-system-configurator

P-10

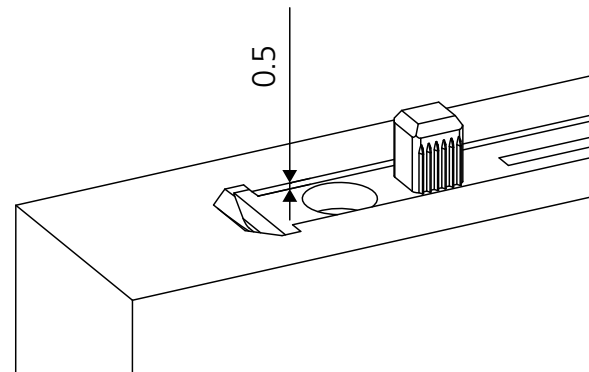
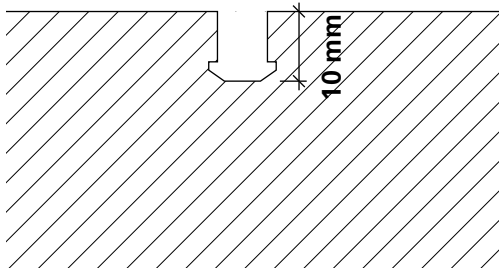

Scharfe Fräser verwenden
Use sharp cutters

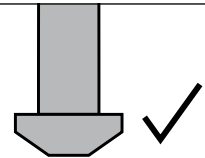
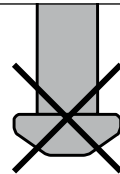

Divario P-18

Tenso P-14

Tenso P-10

Clamex P Medium 14/10

Clamex P-14

Clamex P-10

Bisco P-14 Bisco P-10



Paar/Pair/ Paire/Paio	Art.Nr.
80	145550
300	145560
1000	145570

Paar/Pair/ Paire/Paio	Art.Nr.
80	145415
300	145425
1000	145435

Paar/Pair/ Paire/Paio	Art.Nr.
80	145418
300	145428
1000	145438

Paar/Pair/ Paire/Paio	Art.Nr.
80	145370
300	145371
1000	145357

Paar/Pair/ Paire/Paio	Art.Nr.
80	145334
300	145346
1000	145356

Paar/Pair/ Paire/Paio	Art.Nr.
80	145372
300	145373
1000	145374

Stück/Piece/ Pièce/Pezzi	Art.Nr.
P-10 80	145304
300	145305
P-14 80	145301
300	145302
1000	145303

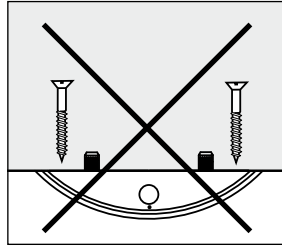
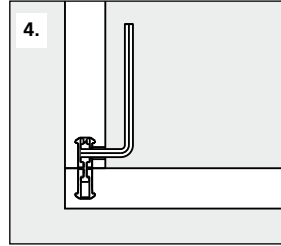
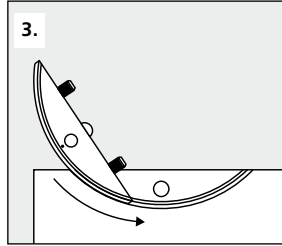
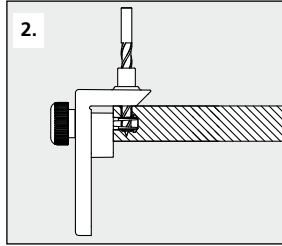
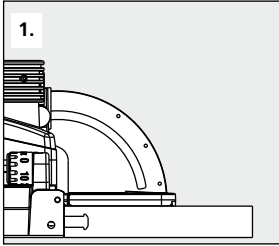
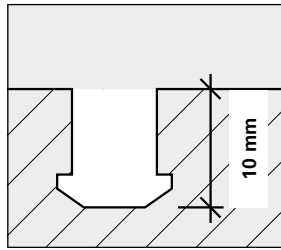
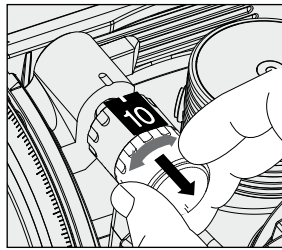
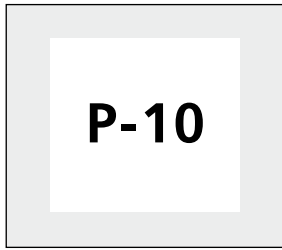
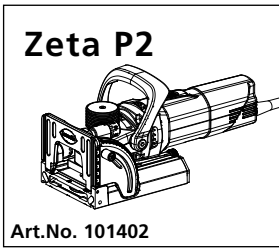

CNC | Partner network: www.lamello.com

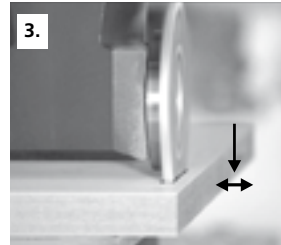
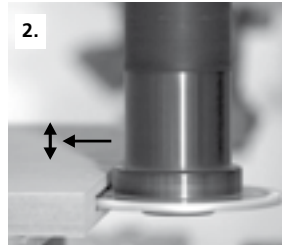
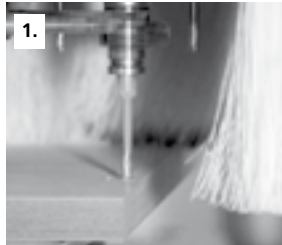
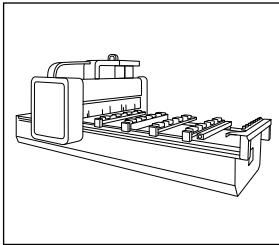

Art. No. 132142
DP, 100.4 x 7 x 30 mm
4 / 6.6 / DTK 48 mm
* Passend zu allen aufgeführten Fräsdornen
Suitable for all cutter arbors listed

Art. No. 132143
DP, 100.4 x 7 x 40 mm
4 / 5.5 / DTK 52 mm

Art. No. 132144
DP, 100.4 x 7 x 16 mm
4 / 5.5 / DTK 28 mm

* **Art. No. 132150**
20 x 50, L = 102 mm

* **Art. No. 132151**
25 x 60, L = 102 mm

* **Art. No. 132152**
16 x 50, L = 85 mm

* **Art. No. 132153**
16 x 55, L = 68 mm

* **Art. No. 132154**
16 x 50, L = 85 mm, mit Spannfläche (2°-schräg) / with clamping surface (2°-angle)

* **Art. No. 132155**
20 x 50, L = 85 mm, mit Spannfläche (2°-schräg) / with clamping surface (2°-angle)

Abdeckkappen / Cover caps
100 Stück / 100 Pieces

90°

RAL	Art. No.
9010	335280
9011	335281
1014	335282
1011	335283
8007	335284
8017	335289
9002	335285
7035	335286
7040	335287
7031	335288
7022	335298

45°

RAL	Art. No.
9010	335380
9011	335381
1014	335382
1011	335383
8017	335384
7022	335388

Art. No. 131556
Ø = 6 / 10 mm
l = 100 / 35 mm

Art. No. 271945
Ø = 4 mm
75 x 55 mm

Art. No. 271945A
Ø = 4 mm
120 x 50 mm

Art. No. 251993
Ø = 4 mm
flexibel

Art. No. 131342
Ø 12 x 40
L = 80 mm

